



RONIS

INDÚSTRIAS METALÚRGICAS, LDA.

CATÁLOGO 2020



Índice

Índice - Index

Pág. 1 - 17	Esquadros Alumínio Aperto Rápido Escuadra de aluminio cierre rápido / Aluminum corner joints
Pág. 18 - 19	Esquadros Alumínio Enchimento Escuadra de aluminio con relleno / Aluminum corner joint with filler
Pág. 20	Uniões de Aperto Topes de zanca / Tightening joints
Pág. 21	Esquadros Alinhamento em Inox e Zamak Ecuadras alineamiento inox / Alignment corner joints in stainless steel and zamak
Pág. 22	Esquadros Alinhamento em Alumínio Ecuadras alineamiento en aluminio / Alignment corner joints in aluminium
Pág. 23	Espelhos Porta Alumínio Espejos de puertas aluminio / Door mirrors aluminium
Pág. 24	Pateres, Sapatas, Remates e Pirâmides Tapa bases, zapatas, remates y pirâmides / Base covers, bases, stops and pyramids
Pág. 25	Puxadores, Torniquetes e Testas Alumínio Tiradores, torniquetes y frentes de aluminio / Door Handles, tourniquets and aluminum head
Pág. 26	Fechos de Embutir Cierres Empotrados / Recessed Locks
Pág. 27	Carros Portão Polias Portón / Rollers Gate
Pág. 28	Segura Portadas e Jogos Nadir Inox Brazo de proyección y juegos nadir inoxidable / Door hinge opener and nadir stainless steel kit
Pág. 29	Guias e Cantoneiras Guías y cenefas / Guides and angles
Pág. 30	Batentes e Rodízios Topes y ruedas de silla / Stops and chair wheels
Pág. 31	Dobradiças Soldar, Puxadores e Reforços Porta Bisagras de soldadura, manijas y refuerzos para puertas/ Welding Hinges, Handles and Door Reinforcements
Pág. 32	Diversos Varios / Various
Pág. 33 - 35	Dobradiças Bisagras / Hinges
Pág. 36	Respiros Rejilla de ventilación / Ventilation grill
Pág. 37	Veda Portas Sells puertas / Door seals

Esquadros Alumínio Aperto Rápido

Escuadra de aluminio cierre rápido / Aluminum corner joint



Ref. RN 001

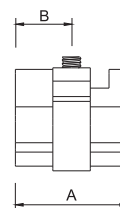
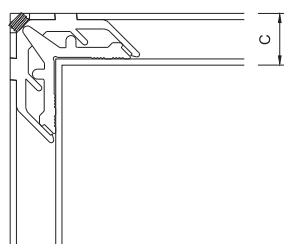

Descrição

descripción / description

Esquadro Alumínio 091

Escuadra Aluminio
Aluminum Corner joint

A - 25; 34; 36; 37

B - Misto *Misto/Mixed*

C - 12 a 14 mm

Descrição

descripción / description

Esquadro Alumínio 092

Escuadra Aluminio
Aluminum Corner joint

A - 22; 25; 34; 36; 37;
41

B - Misto; Centrado;
Descentrado

*Misto/Mixed; Centrado/Centered;
Descentrado/Off center*

C - 14 a 18 mm

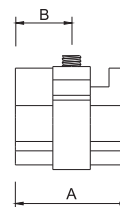
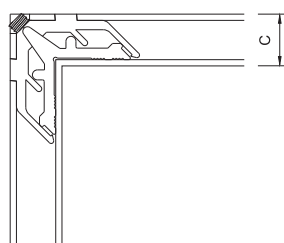

Ref. RN 002



Ref. RN 003

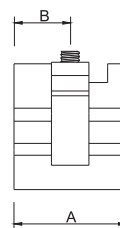
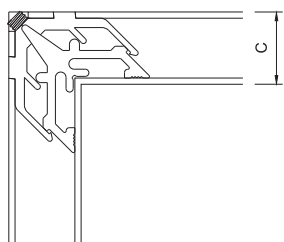

Descrição

descripción / description

Esquadro Alumínio 095

Escuadra Aluminio
Aluminum Corner joint

A - 22; 25; 34; 36; 37;
41

B - Misto; Centrado;
Descentrado

*Misto/Mixed; Centrado/Centered;
Descentrado/Off center*

C - 20 a 23 mm

Descrição

descripción / description

Esquadro Alumínio 092

Escuadra Aluminio
Aluminum Corner joint

A - 22; 25; 34; 36; 37;
41

B - Misto; Centrado;
Descentrado

*Misto/Mixed; Centrado/Centered;
Descentrado/Off center*

C - 14 a 18 mm

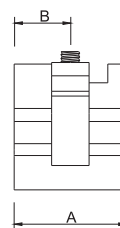
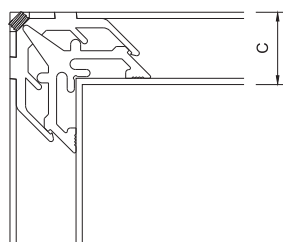

Ref. RN 003 A





Esquadros Alumínio Aperto Rápido

Escuadra de aluminio cierre rápido / Aluminum corner joint

Ref. RN 004

Descrição

descripción / description

Esquadro Alumínio 096

Escuadra Aluminio
Aluminum Corner joint

A - 22; 25; 34; 36; 37;
41

B - Misto; Centrado;
Descentrado

Misto/Mixed; Centrado/Centered;
Descentrado/Off center

C - 27 a 30 mm

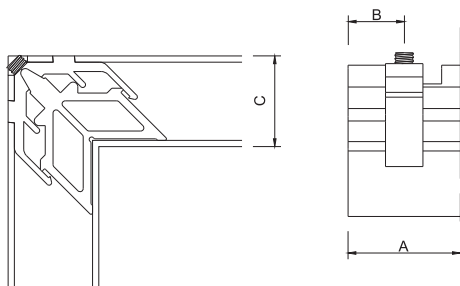

Ref. RN 005

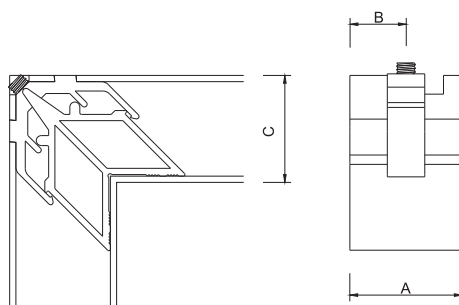
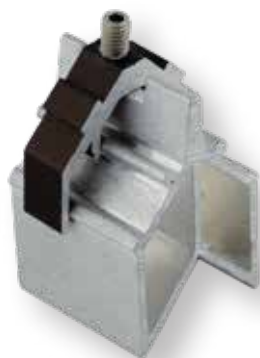

Descrição

descripción / description

Esquadro Alumínio 093

Escuadra Aluminio
Aluminum Corner joint

A - 22; 25; 34; 36; 37;
41

B - Misto; Centrado;
Descentrado

Misto/Mixed; Centrado/Centered;
Descentrado/Off center

C - 31 a 34 mm

Descrição

descripción / description

Esquadro Alumínio 094

Escuadra Aluminio
Aluminum Corner joint

A - 22; 25; 34; 36; 37;
41

B - Misto; Centrado;
Descentrado

Misto/Mixed; Centrado/Centered;
Descentrado/Off center

C - 36 a 39 mm

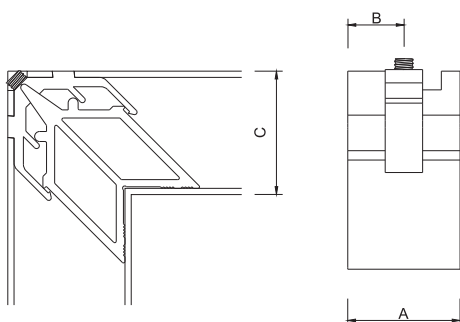

Ref. RN 006



Esquadros Alumínio Aperto Rápido

Escuadra de aluminio cierre rápido / Aluminum corner joint



Ref. RN 011

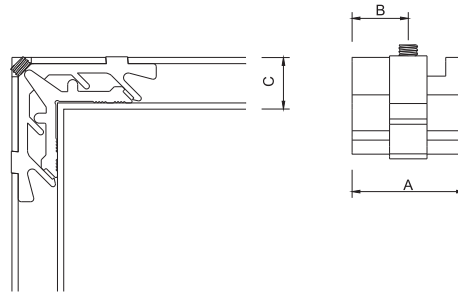

Descrição

descripción / description

Esquadro Alumínio
Escuadra Aluminio
Aluminum Corner joint

A - 22; 25; 34; 36; 37;
41

B - Misto; Centrado;
Descentrado

Misto/Mixed; Centrado/Centered;
Descentrado/Off center

C - 20 a 23 mm

Descrição

descripción / description

Esquadro Alumínio
Escuadra Aluminio
Aluminum Corner joint

A - 22; 25; 34; 36; 37;
41

B - Misto; Centrado;
Descentrado

Misto/Mixed; Centrado/Centered;
Descentrado/Off center

C - 14 a 18 mm

Ref. RN 012

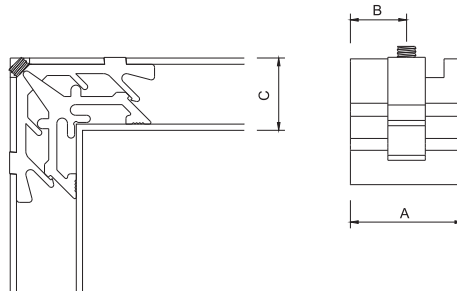

Ref. RN 013

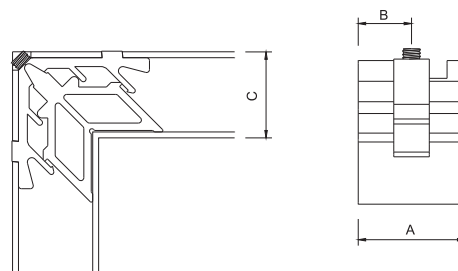

Descrição

descripción / description

Esquadro Alumínio
Escuadra Aluminio
Aluminum Corner joint

A - 22; 25; 34; 36; 37;
41

B - Misto; Centrado;
Descentrado

Misto/Mixed; Centrado/Centered;
Descentrado/Off center

C - 31 a 34 mm

Descrição

descripción / description

Esquadro Alumínio
Escuadra Aluminio
Aluminum Corner joint

A - 22; 25; 34; 36; 37;
41

B - Misto; Centrado;
Descentrado

Misto/Mixed; Centrado/Centered;
Descentrado/Off center

C - 27 a 30 mm

Ref. RN 014

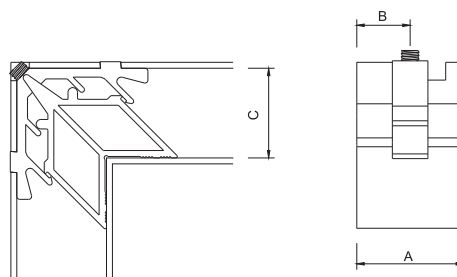

Ref. RN 015

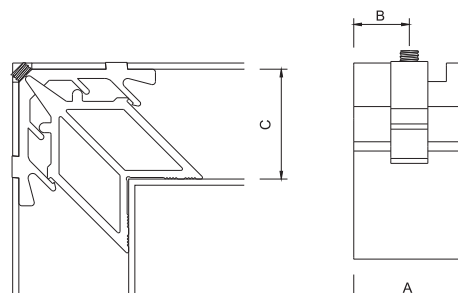

Descrição

descripción / description

Esquadro Alumínio
Escuadra Aluminio
Aluminum Corner joint

A - 22; 25; 34; 36; 37;
41

B - Misto; Centrado;
Descentrado

Misto/Mixed; Centrado/Centered;
Descentrado/Off center

C - 36 a 39 mm



Esquadros Alumínio Aperto Rápido

Escuadra de aluminio cierre rápido / Aluminum corner joint

Descrição

descripción / description

Esquadro Alumínio NT45
Escuadra Aluminio
Aluminum Corner joint

A - 18; 22; 25; 32; 34;
36; 37; 41

B - Centrado;
Descentrado

Centrado/Centered;
Descentrado/Off center

C - 11 a 14 mm

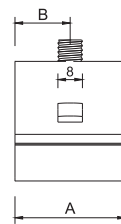
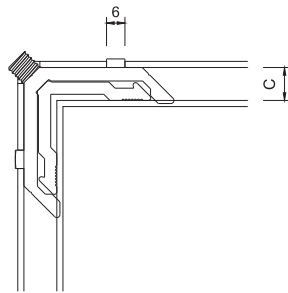

Ref. RN 020



Ref. RN 021

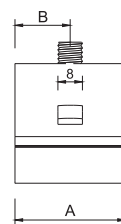
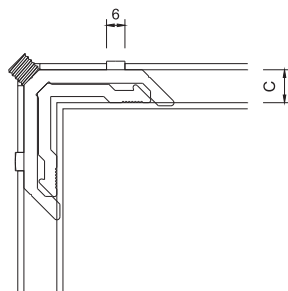

Descrição

descripción / description

Esquadro Alumínio NT45
Escuadra Aluminio
Aluminum Corner joint

A - 18; 22; 25; 32; 34;
36; 37; 41

B - Centrado;
Descentrado

Centrado/Centered;
Descentrado/Off center

C - 14 a 18 mm

Ref. RN 022



Descrição

descripción / description

Esquadro Alumínio NT45
Escuadra Aluminio
Aluminum Corner joint

A - 18; 22; 25; 32; 34;
36; 37; 41

B - Centrado;
Descentrado

Centrado/Centered;
Descentrado/Off center

C - 18 a 23 mm

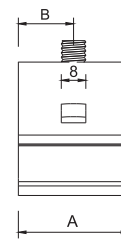
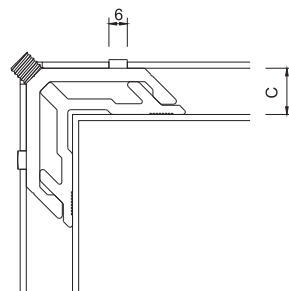

Ref. RN 023

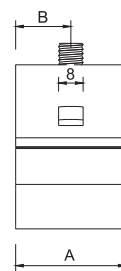
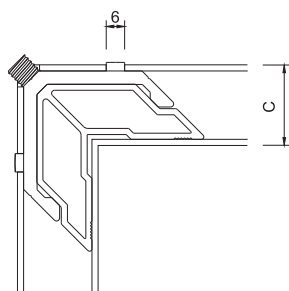

Descrição

descripción / description

Esquadro Alumínio NT45
Escuadra Aluminio
Aluminum Corner joint

A - 18; 22; 25; 32; 34;
36; 37; 41

B - Centrado;
Descentrado

Centrado/Centered;
Descentrado/Off center

C - 22 a 25 mm

Ref. RN 024



Descrição

descripción / description

Esquadro Alumínio NT45
Escuadra Aluminio
Aluminum Corner joint

A - 18; 22; 25; 32; 34;
36; 37; 41

B - Centrado;
Descentrado

Centrado/Centered;
Descentrado/Off center

C - 24 a 27 mm

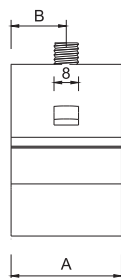
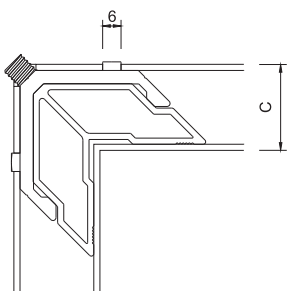



Ref. RN 025

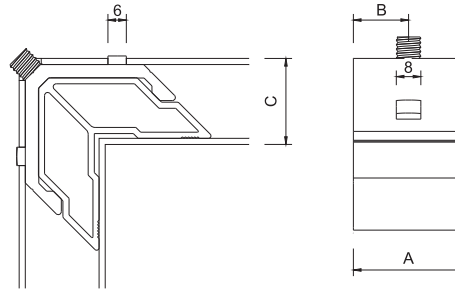

Descrição

descripción / description

Esquadro Alumínio NT45
Escuadra Aluminio
Aluminum Corner joint

A - 18; 22; 25; 32; 34;
36; 37; 41

B - Centrado;
Descentrado

Centrado/Centered;
Descentrado/Off center

C - 31 a 35 mm

Descrição

descripción / description

Esquadro Alumínio NT45
Escuadra Aluminio
Aluminum Corner joint

A - 18; 22; 25; 32; 34;
36; 37; 41

B - Centrado;
Descentrado

Centrado/Centered;
Descentrado/Off center

C - 27 a 31 mm

Ref. RN 026

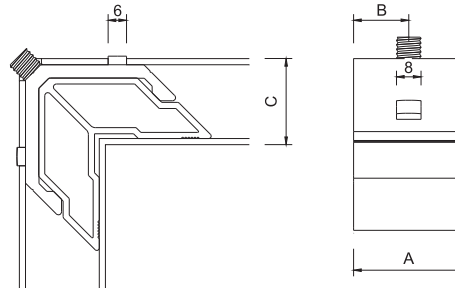

Ref. RN 027

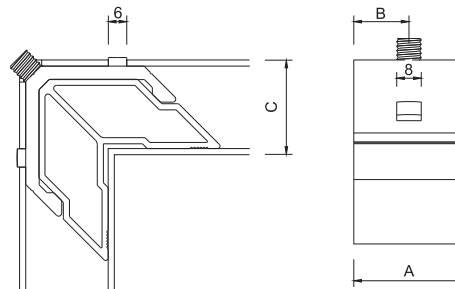

Descrição

descripción / description

Esquadro Alumínio NT45
Escuadra Aluminio
Aluminum Corner joint

A - 18; 22; 25; 32; 34;
36; 37; 41

B - Centrado;
Descentrado

Centrado/Centered;
Descentrado/Off center

C - 36 a 41 mm

Descrição

descripción / description

Esquadro Alumínio NT45
Escuadra Aluminio
Aluminum Corner joint

A - 18; 22; 25; 32; 34;
36; 37; 41

B - Centrado;
Descentrado

Centrado/Centered;
Descentrado/Off center

C - 34 a 39 mm

Ref. RN 028

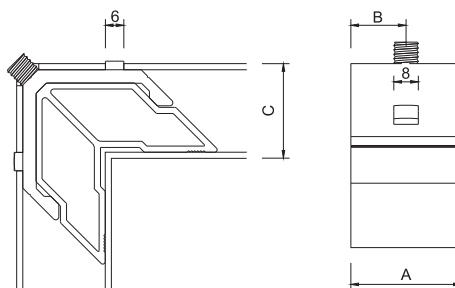

Ref. RN 029

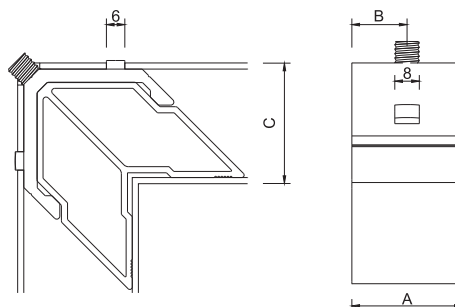

Descrição

descripción / description

Esquadro Alumínio NT45
Escuadra Aluminio
Aluminum Corner joint

A - 18; 22; 25; 32; 34;
36; 37; 41

B - Centrado;
Descentrado

Centrado/Centered;
Descentrado/Off center

C - 41 a 46 mm



Esquadros Alumínio Aperto Rápido

Escuadra de aluminio cierre rápido / Aluminum corner joint

Descrição

descripción / description

Esquadro Alumínio NT46
Escuadra Aluminio
Aluminum Corner joint

A - 18; 22; 25; 32; 34;
36; 37; 41

B - Centrado;
Descentrado

Centrado/Centered;
Descentrado/Off center

C - 14 a 181 mm

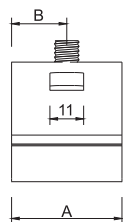
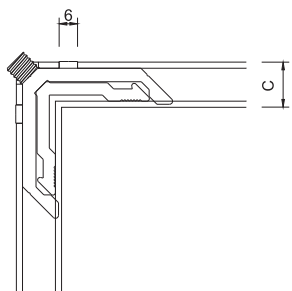

Ref. RN 031



Ref. RN 032

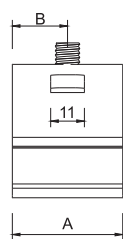
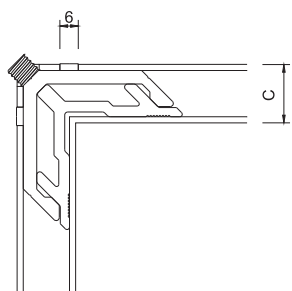

Descrição

descripción / description

Esquadro Alumínio NT46
Escuadra Aluminio
Aluminum Corner joint

A - 18; 22; 25; 32; 34;
36; 37; 41

B - Centrado;
Descentrado

Centrado/Centered;
Descentrado/Off center

C - 18 a 23 mm

Ref. RN 033



Descrição

descripción / description

Esquadro Alumínio NT46
Escuadra Aluminio
Aluminum Corner joint

A - 18; 22; 25; 32; 34;
36; 37; 41

B - Centrado;
Descentrado

Centrado/Centered;
Descentrado/Off center

C - 22 a 25 mm

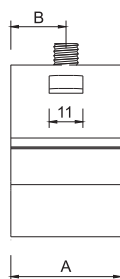
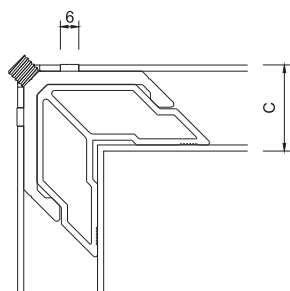

Ref. RN 034

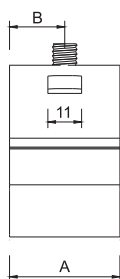
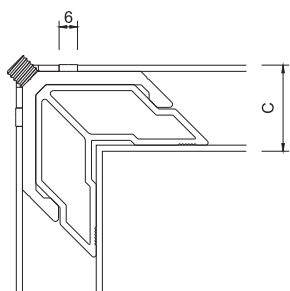

Descrição

descripción / description

Esquadro Alumínio NT46
Escuadra Aluminio
Aluminum Corner joint

A - 18; 22; 25; 32; 34;
36; 37; 41

B - Centrado;
Descentrado

Centrado/Centered;
Descentrado/Off center

C - 24 a 27 mm

Ref. RN 035



Descrição

descripción / description

Esquadro Alumínio NT46
Escuadra Aluminio
Aluminum Corner joint

A - 18; 22; 25; 32; 34;
36; 37; 41

B - Centrado;
Descentrado

Centrado/Centered;
Descentrado/Off center

C - 27 a 31 mm

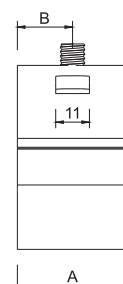
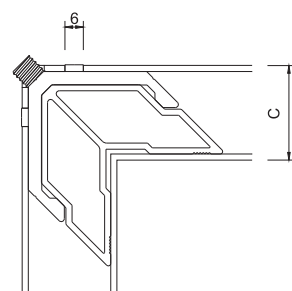

Esquadros Alumínio Aperto Rápido

Escuadra de aluminio cierre rápido / Aluminum corner joint



Ref. RN 036

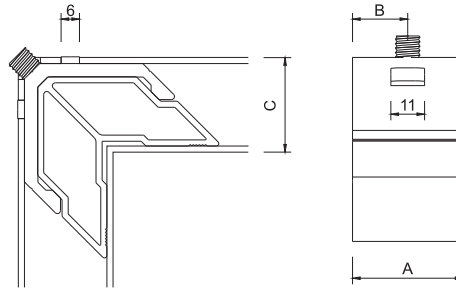

Descrição

descripción / description

Esquadro Alumínio NT46

Escuadra Aluminio
Aluminum Corner joint

A - 18; 22; 25; 32; 34;
36; 37; 41

B - Centrado;
Descentrado

Centrado/Centered;
Descentrado/Off center

C - 31 a 35 mm

Descrição

descripción / description

Esquadro Alumínio NT46

Escuadra Aluminio
Aluminum Corner joint

A - 18; 22; 25; 32; 34;
36; 37; 41

B - Centrado;
Descentrado

Centrado/Centered;
Descentrado/Off center

C - 34 a 39 mm

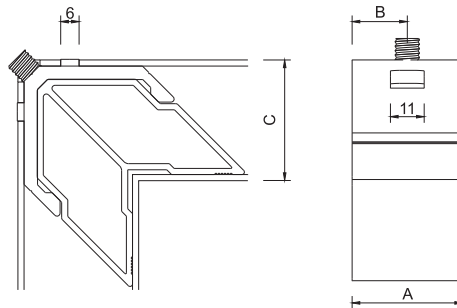

Ref. RN 037



Descrição

descripción / description

Esquadro Alumínio NT46

Escuadra Aluminio
Aluminum Corner joint

A - 18; 22; 25; 32; 34;
36; 37; 41

B - Centrado;
Descentrado

Centrado/Centered;
Descentrado/Off center

C - 36 a 41 mm

Ref. RN 038

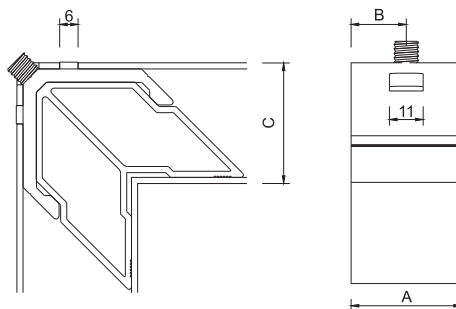

Descrição

descripción / description

Esquadro Alumínio NT46

Escuadra Aluminio
Aluminum Corner joint

A - 18; 22; 25; 32; 34;
36; 37; 41

B - Centrado;
Descentrado

Centrado/Centered;
Descentrado/Off center

C - 41 a 46 mm

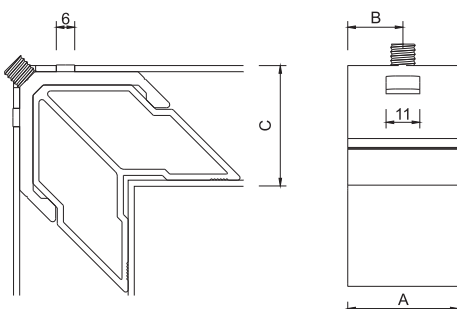

Ref. RN 039





Esquadros Alumínio Aperto Rápido

Escuadra de aluminio cierre rápido / Aluminum corner joint

Descrição

descripción / description

Esquadro Alumínio NT47
Escuadra Aluminio
Aluminum Corner joint

A - 18; 22; 25; 32; 34;
36; 37; 41

B - Centrado;
Descentrado

Centrado/Centered;
Descentrado/Off center

C - 11 a 14 mm

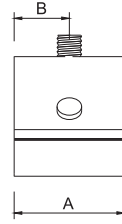
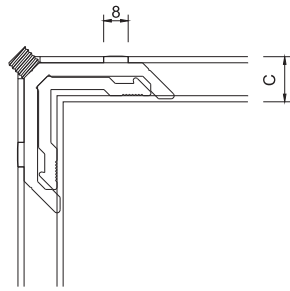

Ref. RN 040



Ref. RN 041

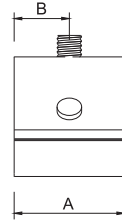
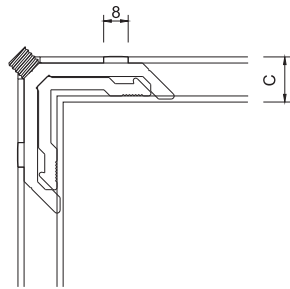

Descrição

descripción / description

Esquadro Alumínio NT46
Escuadra Aluminio
Aluminum Corner joint

A - 18; 22; 25; 32; 34;
36; 37; 41

B - Centrado;
Descentrado

Centrado/Centered;
Descentrado/Off center

C - 14 a 18 mm

Ref. RN 042



Descrição

descripción / description

Esquadro Alumínio NT46
Escuadra Aluminio
Aluminum Corner joint

A - 18; 22; 25; 32; 34;
36; 37; 41

B - Centrado;
Descentrado

Centrado/Centered;
Descentrado/Off center

C - 18 a 23 mm

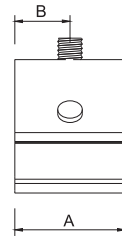
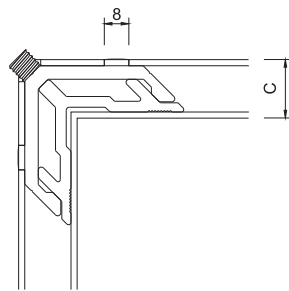

Ref. RN 043

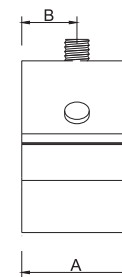
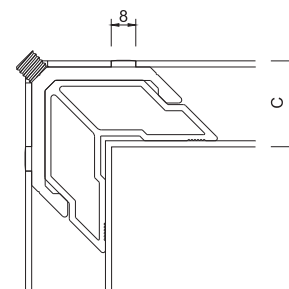

Descrição

descripción / description

Esquadro Alumínio NT46
Escuadra Aluminio
Aluminum Corner joint

A - 18; 22; 25; 32; 34;
36; 37; 41

B - Centrado;
Descentrado

Centrado/Centered;
Descentrado/Off center

C - 22 a 25 mm

Descrição

descripción / description

Esquadro Alumínio NT46
Escuadra Aluminio
Aluminum Corner joint

A - 18; 22; 25; 32; 34;
36; 37; 41

B - Centrado;
Descentrado

Centrado/Centered;
Descentrado/Off center

C - 24 a 27 mm

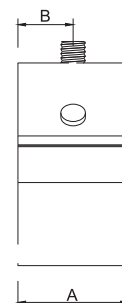
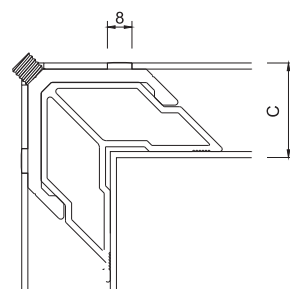

Ref. RN 044





Ref. RN 045

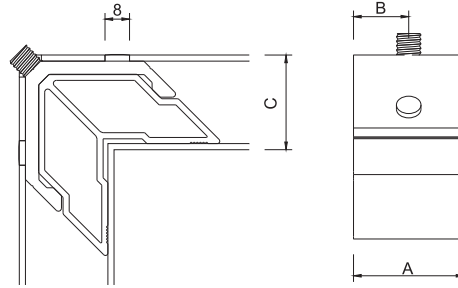

Descrição

descripción / description

Esquadro Alumínio NT47
Escuadra Aluminio
Aluminum Corner joint

A - 18; 22; 25; 32; 34;
36; 37; 41

B - Centrado;
Descentrado

Centrado/Centered;
Descentrado/Off center

C - 31 a 35 mm

Descrição

descripción / description

Esquadro Alumínio NT47
Escuadra Aluminio
Aluminum Corner joint

A - 18; 22; 25; 32; 34;
36; 37; 41

B - Centrado;
Descentrado

Centrado/Centered;
Descentrado/Off center

C - 27 a 31 mm

Ref. RN 046

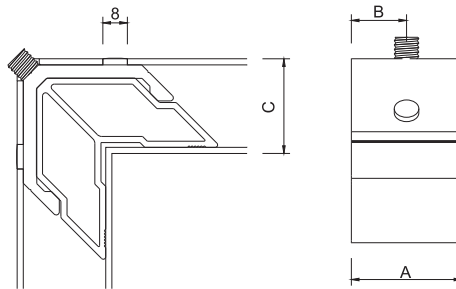

Ref. RN 047

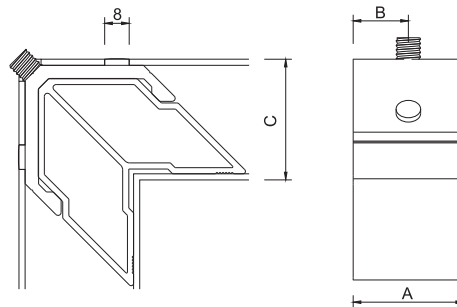

Descrição

descripción / description

Esquadro Alumínio NT47
Escuadra Aluminio
Aluminum Corner joint

A - 18; 22; 25; 32; 34;
36; 37; 41

B - Centrado;
Descentrado

Centrado/Centered;
Descentrado/Off center

C - 34 a 41 mm

Descrição

descripción / description

Esquadro Alumínio NT47
Escuadra Aluminio
Aluminum Corner joint

A - 18; 22; 25; 32; 34;
36; 37; 41

B - Centrado;
Descentrado

Centrado/Centered;
Descentrado/Off center

C - 34 a 39 mm

Ref. RN 048

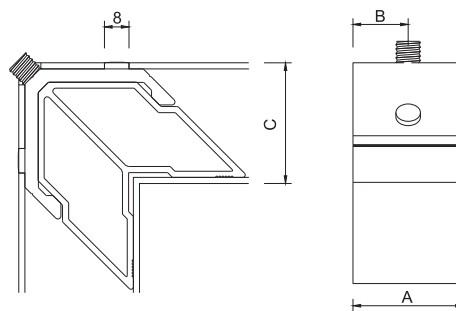

Ref. RN 049

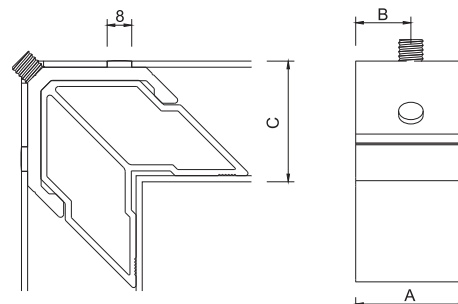

Descrição

descripción / description

Esquadro Alumínio NT46
Escuadra Aluminio
Aluminum Corner joint

A - 18; 22; 25; 32; 34;
36; 37; 41

B - Centrado;
Descentrado

Centrado/Centered;
Descentrado/Off center

C - 41 a 46 mm



Esquadros Alumínio Aperto Rápido

Escuadra de aluminio cierre rápido / Aluminum corner joint

Ref. **RN 051**

Descrição

descripción / description

Esquadro Alumínio NT48

Escuadra Aluminio
Aluminum Corner joint

A - 12; 142; 16; 18; 22;
25

B - Centrado;
Descentrado

Centrado/Centered;
Descentrado/Off center

C - 11 a 14 mm

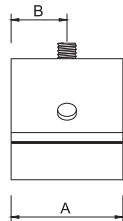
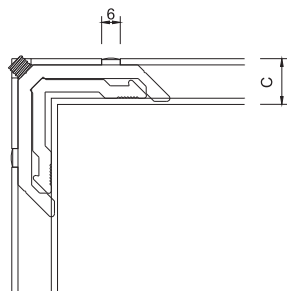

Ref. **RN 052**

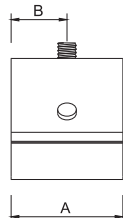
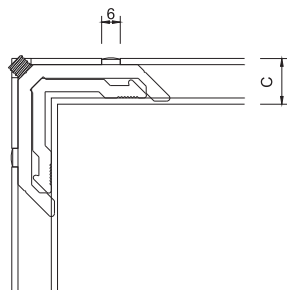

Descrição

descripción / description

Esquadro Alumínio NT48

Escuadra Aluminio
Aluminum Corner joint

A - 12; 14; 16; 18; 22;
25

B - Centrado;
Descentrado

Centrado/Centered;
Descentrado/Off center

C - 14 a 18 mm

Descrição

descripción / description

Esquadro Alumínio NT47

Escuadra Aluminio
Aluminum Corner joint

A - 12; 14; 16; 18; 22;
25

B - Centrado;
Descentrado

Centrado/Centered;
Descentrado/Off center

C - 18 a 23 mm

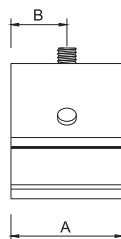
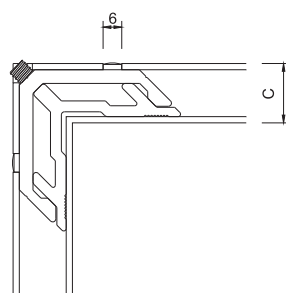

Ref. **RN 053**



Ref. **RN 054**

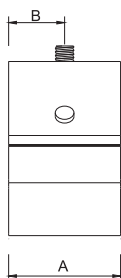
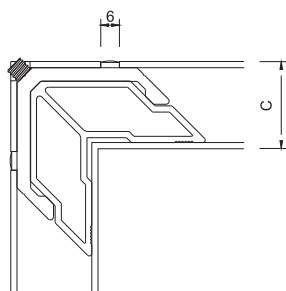

Descrição

descripción / description

Esquadro Alumínio NT48

Escuadra Aluminio
Aluminum Corner joint

A - 12; 14; 16; 18; 22;
25

B - Centrado;
Descentrado

Centrado/Centered;
Descentrado/Off center

C - 22 a 25 mm

Esquadros Alumínio Aperto Rápido

Escuadra de aluminio cierre rápido / Aluminum corner joint



Ref. RN 055

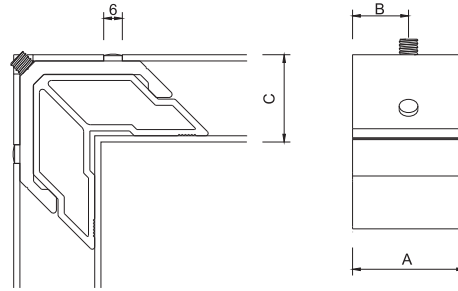

Descrição

descripción / description

Esquadro Alumínio NT48

Escuadra Aluminio
Aluminum Corner joint

A - 12; 14; 16; 18; 22;
35

B - Centrado;
Descentrado

Centrado/Centered;
Descentrado/Off center

C - 24 a 27 mm

Descrição

descripción / description

Esquadro Alumínio NT48

Escuadra Aluminio
Aluminum Corner joint

A - 12; 14; 16; 18; 22;
25

B - Centrado;
Descentrado

Centrado/Centered;
Descentrado/Off center

C - 31 a 35 mm

Ref. RN 056

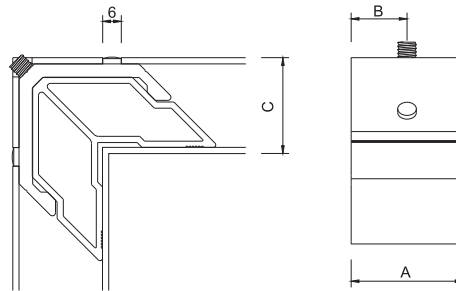

Descrição

descripción / description

Esquadro Alumínio NT48

Escuadra Aluminio
Aluminum Corner joint

A - 12; 14; 16; 18; 22;
25

B - Centrado;
Descentrado

Centrado/Centered;
Descentrado/Off center

C - 36 a 41 mm

Ref. RN 057

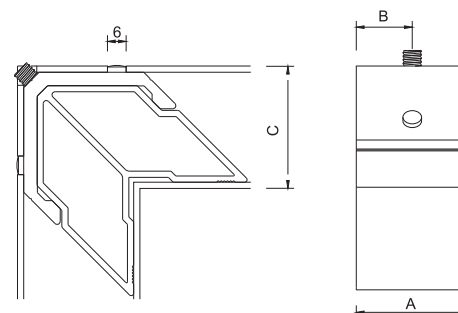



Esquadros Alumínio Aperto Rápido

Escuadra de aluminio cierre rápido / Aluminum corner joint

Ref. **RN 060**

Descrição

descripción / description

Esquadro Alumínio NT49

Escuadra Aluminio
Aluminum Corner joint

A - 9; 12; 14

B - Centrado;
Centrado/Centered;

C - 14 a 18 mm

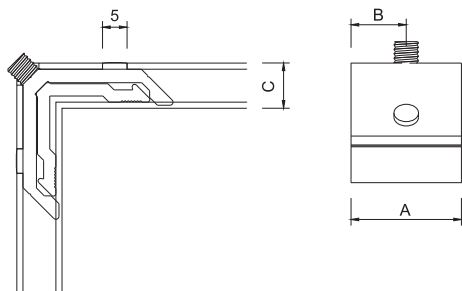

Ref. **RN 061**

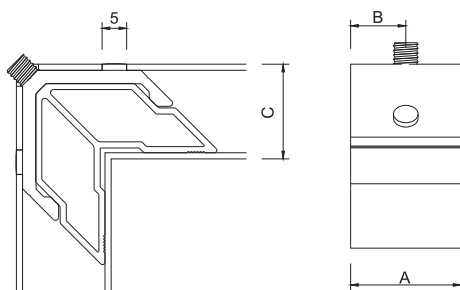

Descrição

descripción / description

Esquadro Alumínio NT49

Escuadra Aluminio
Aluminum Corner joint

A - 9; 12; 14

B - Centrado;
Centrado/Centered;

C - 31 a 35 mm

Ref. **RN 071**

Descrição

descripción / description

Esquadro Perfil Cozinha

Escuadra Aluminio
Aluminum Corner joint

A - 16; 20; 22

B - 31

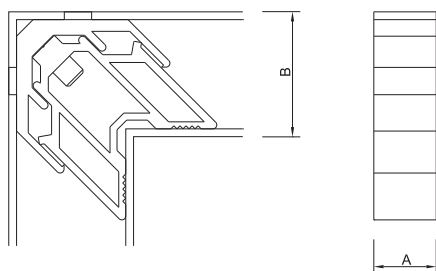

Ref. **RN 081**

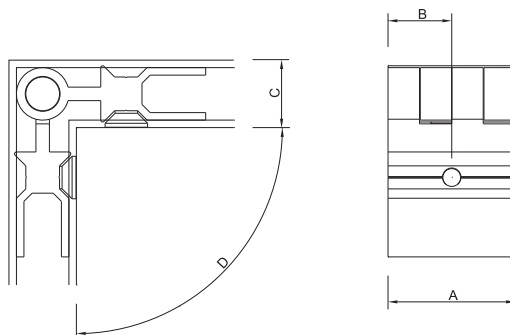

Descrição

descripción / description

Esquadro Angular

Escuadra Aluminio
Aluminum Corner joint

A - 18; 25; 34; 36

B - Centro do esquadro
Centro del escuadra/
Aluminum corner joint center

C - 14

D - 0° a 180°

Esquadros Alumínio Aperto Rápido



Escuadra de aluminio cierre rápido / Aluminum corner joint

Ref. RN 091

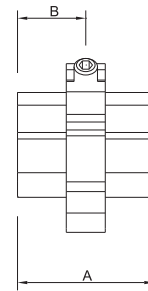
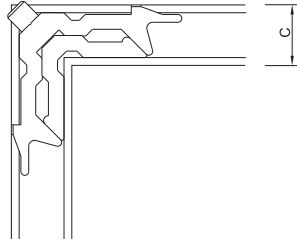

Descrição

descripción / description

Esquadro Alumínio
Escuadra Aluminio
Aluminum Corner joint

A - 21; 23; 25; 37

B - Centrado;
Centrado/Centered;

C - 14 a 18 mm

Ref. RN 092

Descrição

descripción / description

Esquadro Alumínio
Escuadra Aluminio
Aluminum Corner joint

A - 23; 37

B - Centrado;
Centrado/Centered;

C - 31 a 34 mm

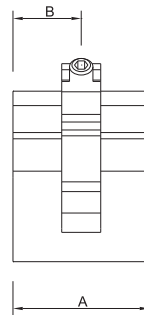
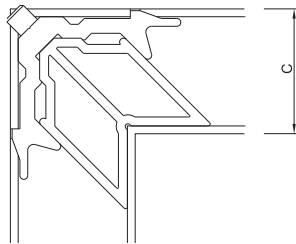

Ref. RN 093

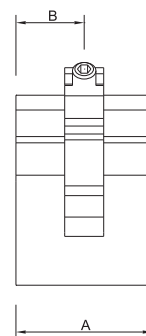
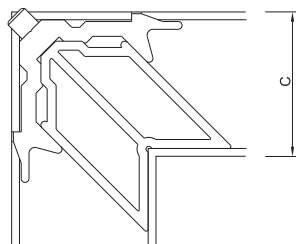

Descrição

descripción / description

Esquadro Alumínio
Escuadra Aluminio
Aluminum Corner joint

A - 23

B - Centrado;
Centrado/Centered;

C - 36 a 39 mm



Esquadros Alumínio Aperto Rápido

Escuadra de aluminio cierre rápido / Aluminum corner joint

Ref. **RN 101**

Descrição

descripción / description

Esquadro Alumínio
Escuadra Aluminio
Aluminum Corner joint

A - Pedido Cliente

Aplicación client
Customer request

B - Centrado;
Descentrado

Centrada/Centered;
Descentrada/Off center

C - 12,5 a 16,5 mm

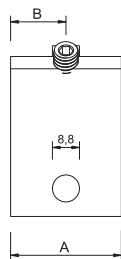
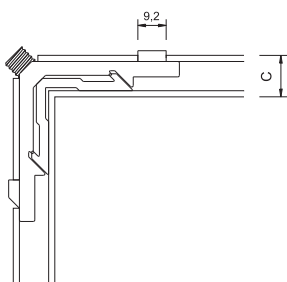

Ref. **RN 102**

Descrição

descripción / description

Esquadro Alumínio
Escuadra Aluminio
Aluminum Corner joint

A - Pedido Cliente

Aplicación client
Customer request

B - Centrado;
Descentrado

Centrada/Centered;
Descentrada/Off center

C - 14,5 a 18,5 mm

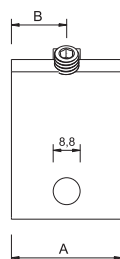
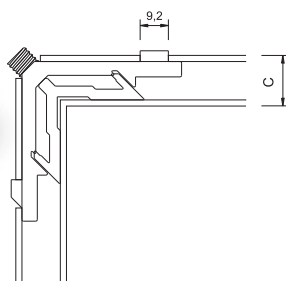

Ref. **RN 103**

Descrição

descripción / description

Esquadro Alumínio
Escuadra Aluminio
Aluminum Corner joint

A - Pedido Cliente

Aplicación client
Customer request

B - Centrado;
Descentrado

Centrada/Centered;
Descentrada/Off center

C - 16,5 a 20,5 mm

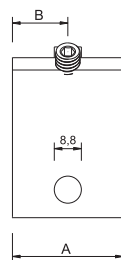
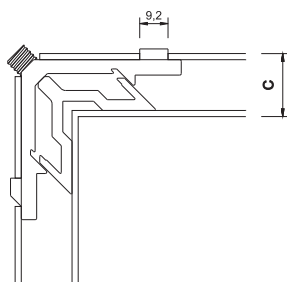

Ref. **RN 104**

Descrição

descripción / description

Esquadro Alumínio
Escuadra Aluminio
Aluminum Corner joint

A - Pedido Cliente

Aplicación client
Customer request

B - Centrado;
Descentrado

Centrada/Centered;
Descentrada/Off center

C - 21,5 a 25,5 mm

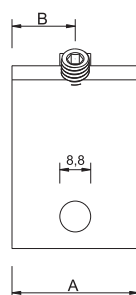
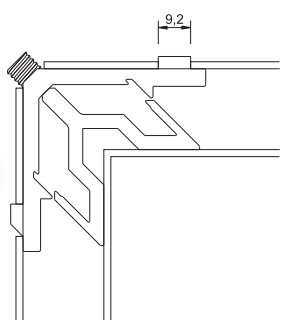

Esquadros Alumínio Aperto Rápido

Escuadra de aluminio cierre rápido / Aluminum corner joint



Ref. RN 105

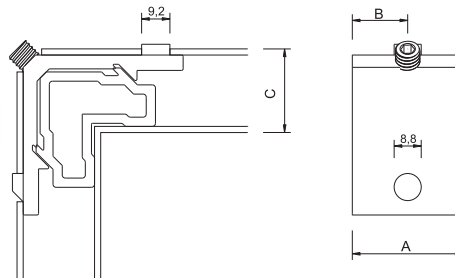

Descrição

descripción / description

Esquadro Alumínio
Escuadra Aluminio
Aluminum Corner joint

A - Pedido Cliente

Aplicación client
Customer request

B - Centrado;
Descentrado

Centrada/Centered;
Descentrada/Off center

C - 26,5 a 30,5 mm

Descrição

descripción / description

Esquadro Alumínio
Escuadra Aluminio
Aluminum Corner joint

A - Pedido Cliente

Aplicación client
Customer request

B - Centrado;
Descentrado

Centrada/Centered;
Descentrada/Off center

C - 32,5 a 36,5 mm

Ref. RN 106

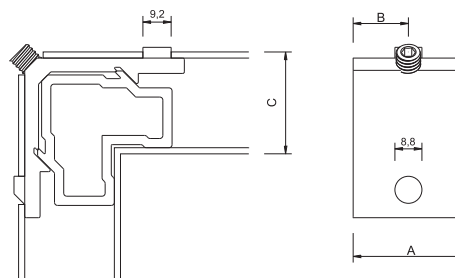

Descrição

descripción / description

Esquadro Alumínio
Escuadra Aluminio
Aluminum Corner joint

A - Pedido Cliente

Aplicación client
Customer request

B - Centrado;
Descentrado

Centrada/Centered;
Descentrada/Off center

C - 35,5 a 37,5 mm

Ref. RN 107

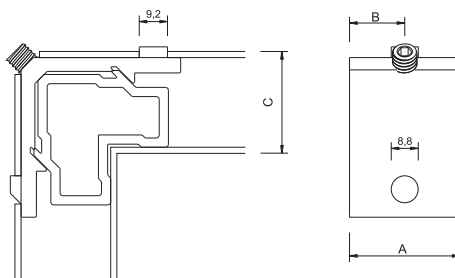

Descrição

descripción / description

Esquadro Alumínio
Escuadra Aluminio
Aluminum Corner joint

A - Pedido Cliente

Aplicación client
Customer request

B - Centrado;
Descentrado

Centrada/Centered;
Descentrada/Off center

C - 42,5 a 46,5 mm

Ref. RN 108

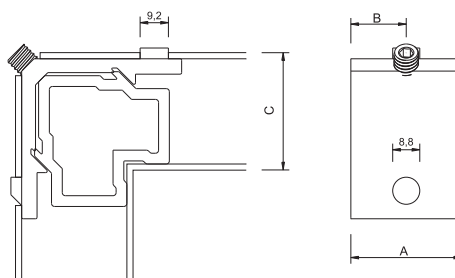



Esquadros Alumínio Aperto Rápido

Escuadra de aluminio cierre rápido / Aluminum corner joint

Descrição

descripción / description

Esquadro Alumínio
Escuadra Aluminio
Aluminum Corner joint

A - Pedido Cliente

Aplicación client
Customer request

B - Centrado;
Descentrado

Centrado/Centered;
Descentrado/Off center

C - 12,5 a 16,5 mm

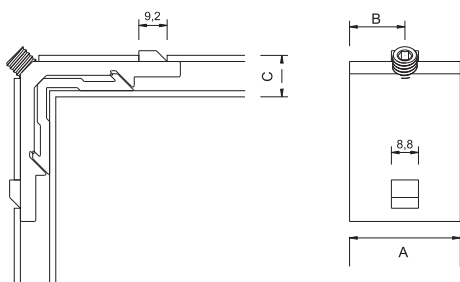

Ref. RN 111



Ref. RN 112

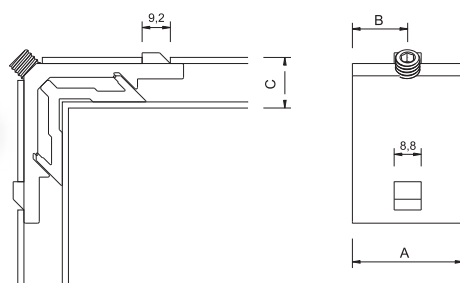

Descrição

descripción / description

Esquadro Alumínio
Escuadra Aluminio
Aluminum Corner joint

A - Pedido Cliente

Aplicación client
Customer request

B - Centrado;
Descentrado

Centrado/Centered;
Descentrado/Off center

C - 14,5 a 18,5 mm

Descrição

descripción / description

Esquadro Alumínio
Escuadra Aluminio
Aluminum Corner joint

A - Pedido Cliente

Aplicación client
Customer request

B - Centrado;
Descentrado

Centrado/Centered;
Descentrado/Off center

C - 16,5 a 20,5 mm

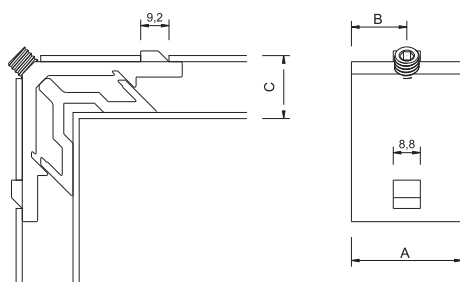

Ref. RN 113



Ref. RN 114

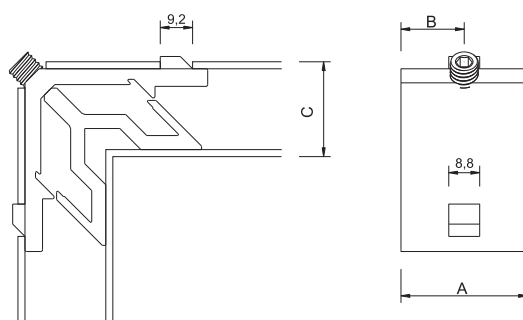

Descrição

descripción / description

Esquadro Alumínio
Escuadra Aluminio
Aluminum Corner joint

A - Pedido Cliente

Aplicación client
Customer request

B - Centrado;
Descentrado

Centrado/Centered;
Descentrado/Off center

C - 21,5 a 25,5 mm

Esquadros Alumínio Aperto Rápido

Escuadra de aluminio cierre rápido / Aluminum corner joint



Ref. RN 115

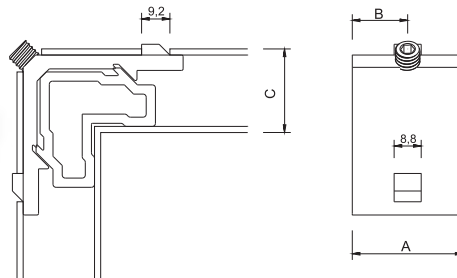

Descrição

descripción / description

Esquadro Alumínio
Escuadra Aluminio
Aluminum Corner joint

A - Pedido Cliente
Aplicación client
Customer request

B - Centrado;
Descentrado
Centrado/Centered;
Descentrado/Off center

C - 26,5 a 30,5 mm

Descrição

descripción / description

Esquadro Alumínio
Escuadra Aluminio
Aluminum Corner joint

A - Pedido Cliente
Aplicación client
Customer request

B - Centrado;
Descentrado
Centrado/Centered;
Descentrado/Off center

C - 32,5 a 36,5 mm

Ref. RN 116

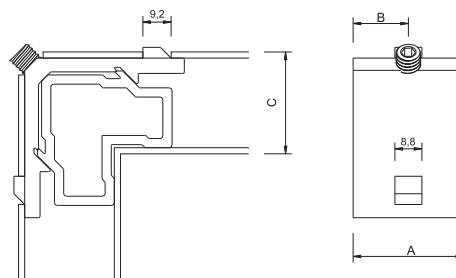

Descrição

descripción / description

Esquadro Alumínio
Escuadra Aluminio
Aluminum Corner joint

A - Pedido Cliente
Aplicación client
Customer request

B - Centrado;
Descentrado
Centrado/Centered;
Descentrado/Off center

C - 35,5 a 37,5 mm

Ref. RN 117

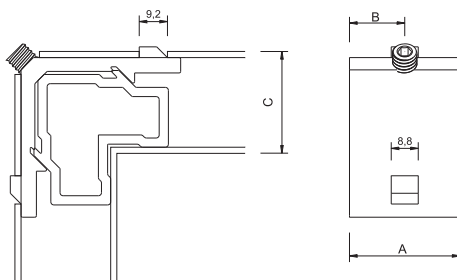

Descrição

descripción / description

Esquadro Alumínio
Escuadra Aluminio
Aluminum Corner joint

A - Pedido Cliente
Aplicación client
Customer request

B - Centrado;
Descentrado
Centrado/Centered;
Descentrado/Off center

C - 42,5 a 46,5 mm

Ref. RN 118

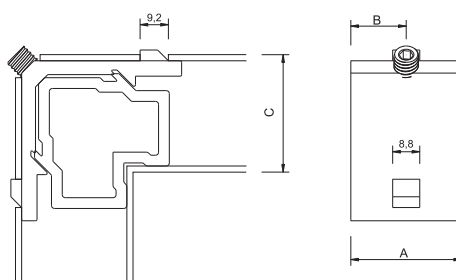



Esquadros Alumínio Enchimento

Escuadra de aluminio com relleno / Aluminum corner joint with filler

Descrição

descripción / description

Esquadro Alumínio
Escuadra Aluminio
Aluminum Corner joint

A - Pedido Cliente

Aplicación client
Customer request

B - 6 mm

Ref. RN 120

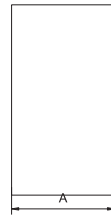
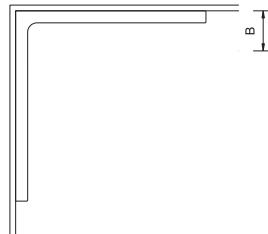

Ref. RN 130

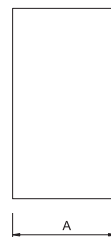
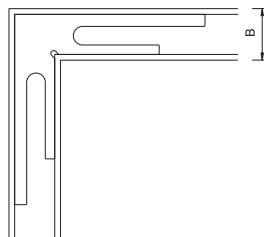

Descrição

descripción / description

Esquadro Alumínio
Escuadra Aluminio
Aluminum Corner joint

A - 25; 34; 36

B - 14,5 mm

Descrição

descripción / description

Esquadro Alumínio
Escuadra Aluminio
Aluminum Corner joint

A - 25; 34; 36

B - 30 mm

Ref. RN 140

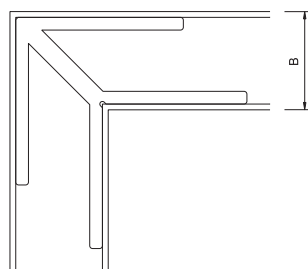

Esquadros Alumínio Enchimento

Escuadra de alumínio com relleno / Aluminum corner joint with filler



Ref. RN 150

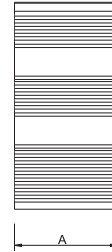
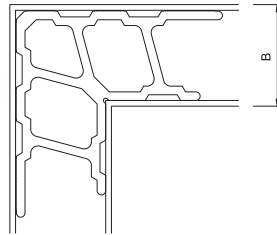

Descrição

descripción / description

Esquadro Alumínio
Escuadra Aluminio
Aluminum Corner joint

A - 25; 34; 36

B - 31,5 mm

Descrição

descripción / description

Esquadro Alumínio
Escuadra Aluminio
Aluminum Corner joint

A - 23; 336

B - 40 mm

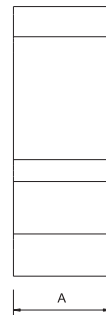
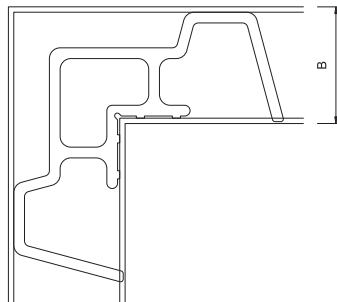

Ref. RN 160



Ref. RN 170

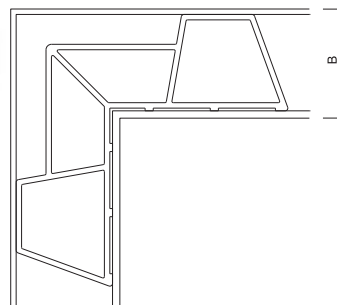

Descrição

descripción / description

Esquadro Alumínio
Escuadra Aluminio
Aluminum Corner joint

A - 23; 25

B - 25 mm



Uniões de Aperto

Topes de zanca / Tightening joints

Ref. **RN 200**



Descrição
 descripción / description

União pequena S/40
 Topes de zanca pequena
 Small union

Ref. **RN 200 A**



Descrição
 descripción / description

União grande S/40
 Topes de zanca grande
 Big union

Ref. **RN 210**



Descrição
 descripción / description

União pequena S/2000 CE
 Topes de zanca pequena
 Small union

Ref. **RN 210 A**



Descrição
 descripción / description

União grande S/2000 CE
 Topes de zanca grande
 Big union

Ref. **RN 220**



Descrição
 descripción / description

União pequena de Travessa S740
 Topes de zanca plato pequena
 Small union with platter

Ref. **RN 220 A**



Descrição
 descripción / description

União grande de Travessa S740
 Topes de zanca plato grande
 Big union with platter



Ref. 230

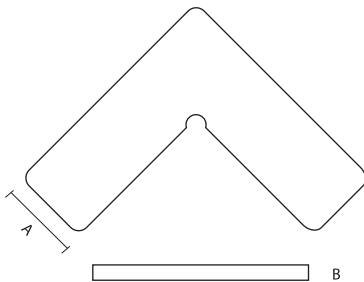
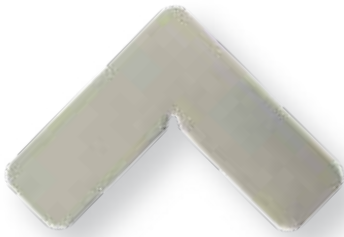

Descrição
descripción / description

A - 4,7; 5; 5,5; 6
7,2; 7,7; 8,5; 9,5;
12,5; 13,5; 15;
17,4; 20,8; 22,7
23,6; 25,7; 31,8
32,2; 35; 38; 44
B - 0,8; 1; 1,2; 1,5

Ref. 240

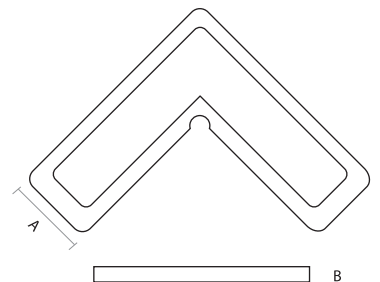
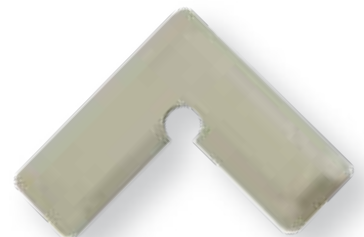

Descrição
descripción / description

A - 6,5; 14,5; 21,5
23; 26
B - 1,2; 1,5; 2; 2,5

Ref. 250

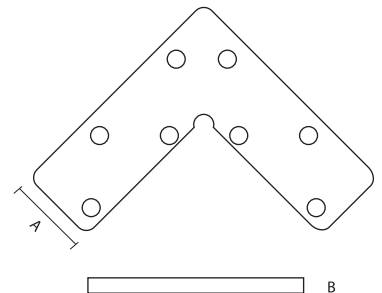

Descrição
descripción / description

A - 7; 7,5; 7,7; 8,8
12,8; 13,4; 14,2;
14,8; 15,1
B - 0,8; 1; 1,2;

Ref. 260

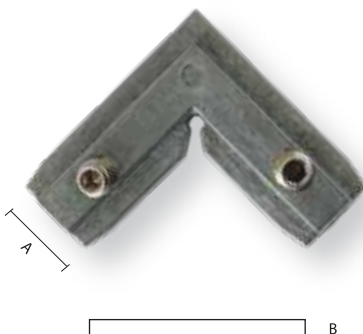

Descrição
descripción / description

A - 12
B - 3,60

Descrição
descripción / description

A - 9
B - 3,80

Ref. 270

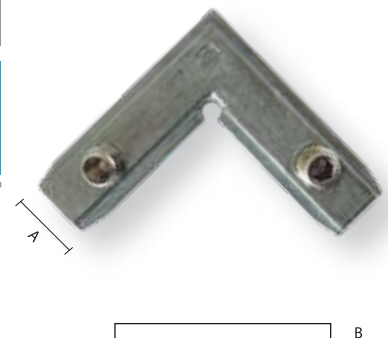



Esquadros Alinhamento em Alumínio

Escuadras alineamiento en aluminio / Alignment corner joints in aluminium

Ref. **RN 280.A14**



Descrição
descripción / description

A - 14
B - 5

Descrição
descripción / description

A - 25
B - 5

Ref. **280.A25**

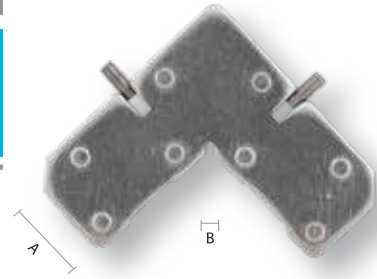

Ref. **RN 280.A11**



Descrição
descripción / description

A - 11
B - 5

Descrição
descripción / description

A - 14
B - 6, 7, 10
C - 23, 5

Ref. **2500**

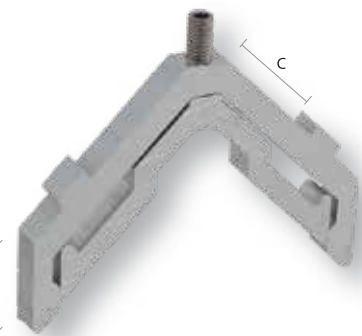

Ref. **2510**

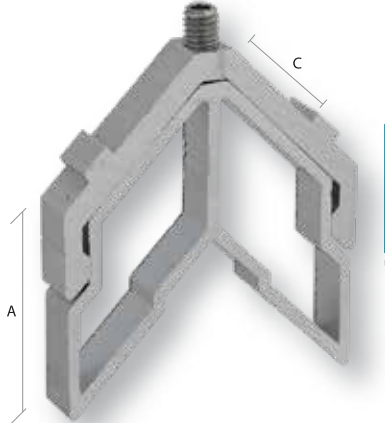

Descrição
descripción / description

A - 31
B - 6, 7, 10
C - 23, 5

Descrição
descripción / description

A - 36
B - 6, 7, 10
C - 23, 5

Ref. **2520**

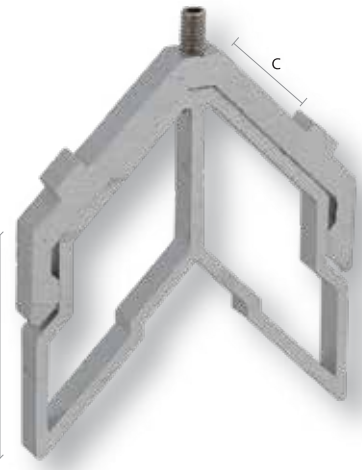

Ref. **RN 150.A7**

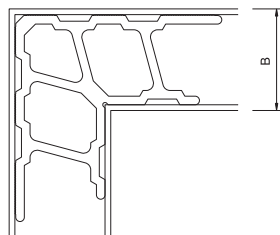
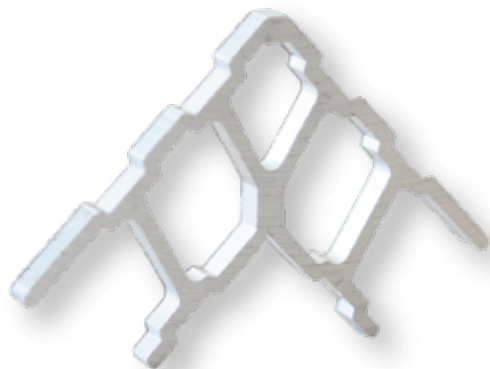

Descrição
descripción / description

A - 7
B - 31.5



Ref. RN 300

Descrição

descripción / description

Espelho Ref. 02

Espejo / Mirror

Lacado; Anodizado

Lacado / Lacquered

Anodizado / Anodized

A - 30; B - 70; C - 7



Ref. RN 301

Descrição

descripción / description

Espelho Oval Ref. 01

Espejo oval / Oval mirror

Lacado; Anodizado

Lacado / Lacquered

Anodizado / Anodized

A - 30; B - 70; C - 7



Ref. RN 302

Descrição

descripción / description

Espelho Oval Ref. 02

Espejo oval / Oval mirror

Lacado; Anodizado

Lacado / Lacquered

Anodizado / Anodized

A - 30; B - 68; C - 6





Pateres, Sapatas, Remates e Pirâmides

Tapa bases, zapatas, remates y pirâmides / Base covers, bases, stops and pyramids

Ref. RN 400

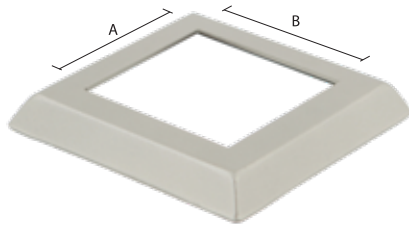

Descrição

descripción / description

Pateres Alumínio para o tubo

Tapa bases para el tubo
Base covers for the tube

Lacado; Anodizado
Lacado / Lacquered
Anodizado / Anodized

A - 30; 65; 75

B - 60; 65; 75

Ref. RN 401

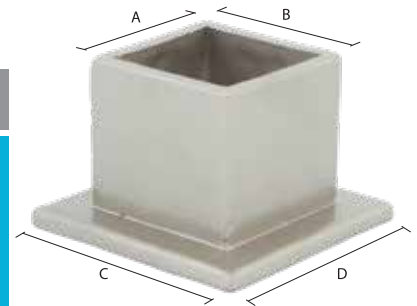

Descrição

descripción / description

Sapatas Alumínio para o tubo

Zapata base para el tubo
Base for the tube

Lacado

Lacado / Lacquered

A - 60; 70

B - 60; 70

Base

Para tubo 65

Para tubo / For tube
C - 93 / D - 93

Para tubo 75

Para tubo / For tube
C - 103 / D - 103

Ref. RN 402



Descrição

descripción / description

Remates Bola Alumínio para o tubo

Remates bola aluminio para el tubo
Aluminum base ball stop for the tube

Lacado

Lacado / Lacquered

65 x 65; 75 x 75;

Base

Para tubo 65

Para tubo / For tube
A - 60 / B - 60

Para tubo 75

Para tubo / For tube
A - 65 / B - 65

Descrição

descripción / description

Pirâmide Alumínio para o tubo

Pirâmide aluminio para el tubo
Aluminum pyramid for the tube

Lacado

Lacado / Lacquered

65 x 65; 75 x 75;

Ref. RN 403



Base

Para tubo 65

Para tubo / For tube
A - 60 / B - 60

Para tubo 75

Para tubo / For tube
A - 65 / B - 65

Ref. RN 404

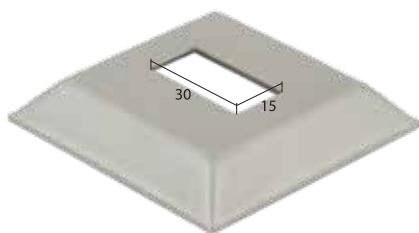

Descrição

descripción / description

Pateres Alumínio

Tapa base
Base covers

Lacado; Anodizado
Lacado / Lacquered
Anodizado / Anodized

30 x 15

Ref. RN 405



Descrição

descripción / description

Sapata Alumínio para o tubo

Zapata base para el tubo
Base for the tube

Lacado

Lacado / Lacquered

30 x 30

Base

Para tubo 30x30

Para tubo / For tube
A - 59 / B - 59

Base

Para tubo 65

Para tubo / For tube
C - 93 / D - 93

Para tubo 75

Para tubo / For tube
C - 103 / D - 103

Puxadores, Torniquetes e Testas Alumínio



Tiradores, torniquetes y frentes de aluminio / Door handles, tourniquets and aluminum head

Ref. RN 500



6

Descrição

descripción / description

Torniquete Argola
Torniquete anillo
Tourniquet ring

Lacado
Lacado / Lacquered

Ref. RN 600



80

Ref. RN 700

Descrição

descripción / description

Testas em Alumínio
Frentes de aluminio
Aluminum heads

Lacado
Lacado / Lacquered

Descrição

descripción / description

Puxador Bola 80 Liso
Tirador bola 80 liso
Door handle Ball 80 smooth

Lacado
Lacado / Lacquered

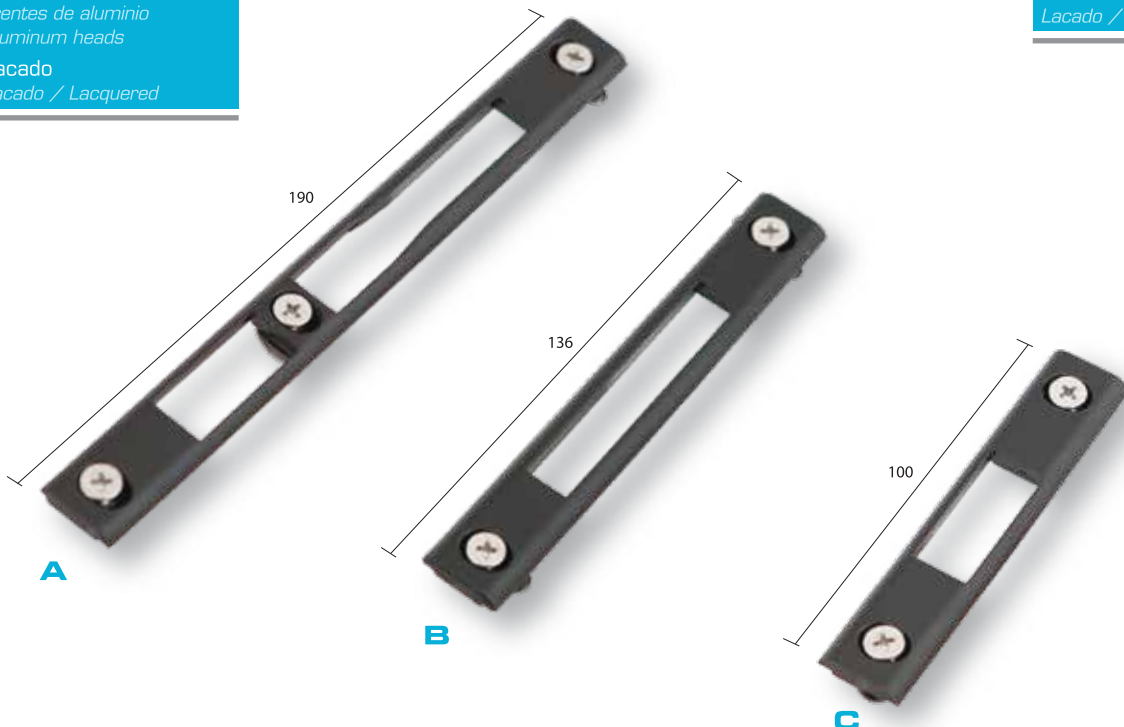



Fechos de Embutir

Cierres Empotrados / Recessed Locks

Ref. RN 800

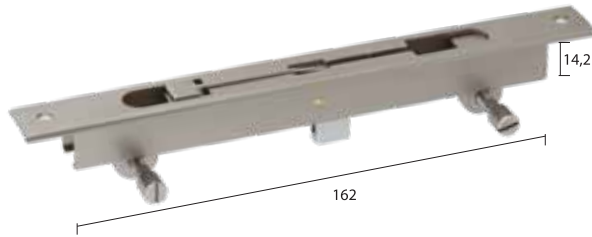

Descrição

descripción / description

Fecho Duplo Ronis

Doble cierre

Double lock

Lacado

Lacado / Lacquered

Aplicação Lateral

Aplicación lateral para la

barra cremone / Lateral

application for cremone bar

Descrição

descripción / description

Fecho Duplo Ronis

Doble cierre

Double lock

Lacado

Lacado / Lacquered

Aplicação Frontal

Aplicación frontal para la

barra cremone / Front

application for cremone bar

Ref. RN 800 A



Ref. RN 900

Descrição

descripción / description

Fecho de 2 / Folha

Cierre de 2 hojas

2 sheet lock

Lacado

Lacado / Lacquered

A - 150

B - 14

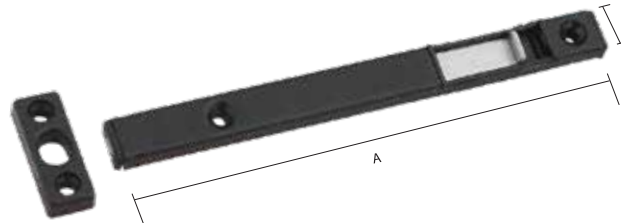

Descrição

descripción / description

Fecho de Culatra

Cierre de bloqueo

Breach lock

Lacado

Lacado / Lacquered

A - 70; 120; 220

Ref. RN 1000

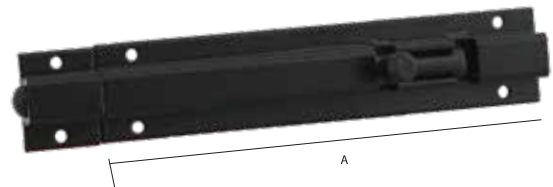

Ref. RN 1050

Descrição

descripción / description

Fecho de Embutir 8000

Cierre de embutir

Inlay lock

Lacado

Lacado / Lacquered

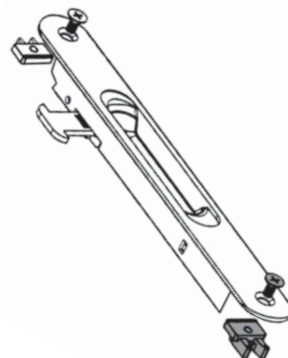

Ref. RN 1051

Descrição

descripción / description

Fecho de Embutir 8500

Cierre de embutir

Inlay lock

Lacado

Lacado / Lacquered





Ref. 1100

Descrição

descripción / description

Carro nº 14

Polia / Roller

Zincado

Cinc / Zinc plated

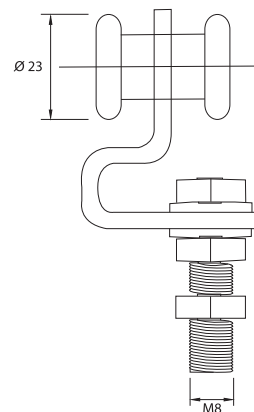

Ref. 1150

Descrição

descripción / description

Carro nº 12

Polia / Roller

Zincado

Cinc / Zinc plated

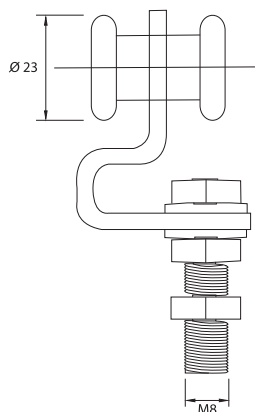

Ref. 1200

Descrição

descripción / description

Carro nº 35 S

Polia / Roller

Zincado

Cinc / Zinc plated

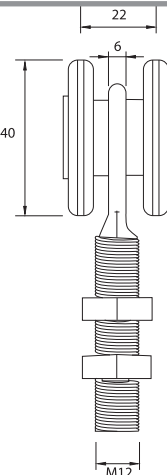

Ref. 1250

Descrição

descripción / description

Carro nº 35 D

Polia / Roller

Zincado

Cinc / Zinc plated

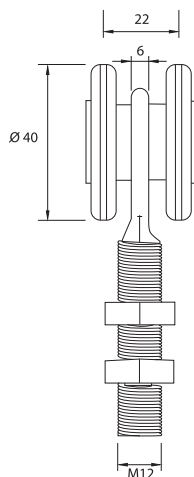



Segura Portadas e Jogos Nadir Inox

Bravo de projección y juegos nadir inoxidable / Door hinge opener and nadir stainless steel kit

Ref. **RN 1300**

Esquerdo



Ref. **RN 1300 A**

Direito



Descrição

descripción / description

Segura Portadas Inox

L visível

Bravo de projección inoxidable

L visible

Door hinge opener

L visible

Ref. **RN 1400**

Esquerdo



Ref. **RN 1400 A**

Direito



Descrição

descripción / description

Jogos Nadir Inox

Juegos nadir inoxidable

Nadir stainless steel kit

Ref. **RN 1500**

Esquerdo



Ref. **RN 1500 A**

Direito



Descrição

descripción / description

Jogos Nadir Inox

Série A40; A6

Juegos nadir inoxidable

Nadir stainless steel kit



Ref. RN 1600

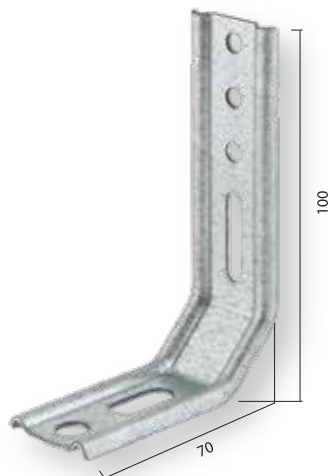

Descrição

descripción / description

Cantoneira Zincada 5x8

Cenefa galvanizada
Galvanized angle

Ref. RN 1610



Descrição

descripción / description

Cantoneira Zincada 5x11

Cenefa galvanizada
Galvanized angle

Ref. RN 1620



Descrição

descripción / description

Chapa Zincada Ângulo

Hoja galvanizada ángulo
Galvanized angle plate

Descrição

descripción / description

Guia Portão

Guía puerta / Gate guide

Alumínio ou lacado

Aluminio o lacado
Aluminum or laquered

Ref. RN 1700 B

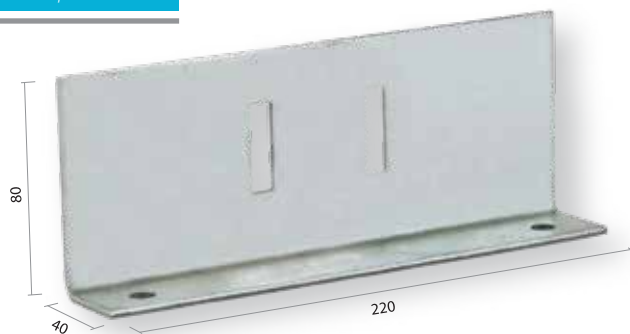

Ref. RN 1700 A



Descrição

descripción / description

Guia Portão

Guía puerta / Gate guide

Alumínio ou lacado

Aluminio o lacado
Aluminum or laquered

Ref. RN 1700



Descrição

descripción / description

Guia Portão

Guía puerta / Gate guide

Alumínio ou lacado

Aluminio o lacado
Aluminum or laquered



Batentes e Rodízios

Topes y ruedas de silla / Stops and Chair Wheels

Ref. RN 1010

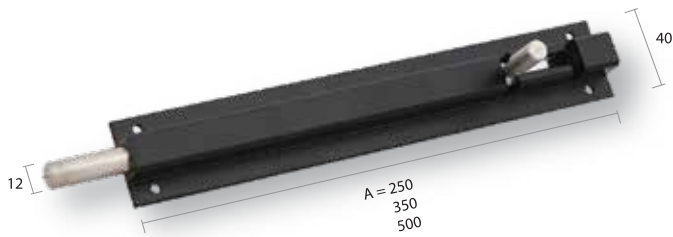

Descrição

descripción / description

Fecho culatra para portão lacado
Cerradura para puerta lacada
/Breech closure for lacquered gate
A - 250, 350, 500

Ref. RN 1710

Descrição

descripción / description

Rodízio
Ruedas de silla
Chair wheels
25



Ref. RN 1711

Descrição

descripción / description

Rodízio
Ruedas de silla
Chair wheels
30 • 32



Ref. RN 1721

Descrição

descripción / description

Batente Portão móvel
Tope puerta móvil
Gate stop mobile

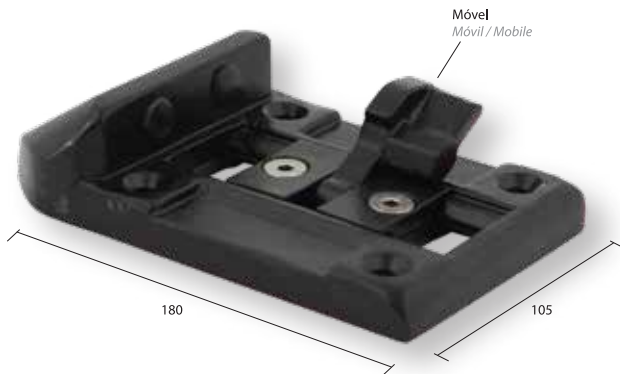

Ref. RN 180

Descrição

descripción / description

Esquadro Portão
Soporte puerta
Gate bracket

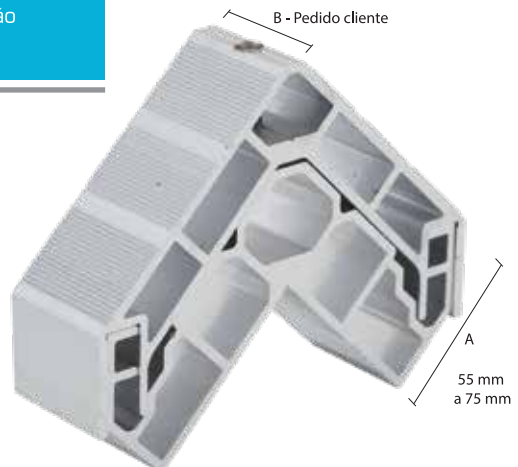

Ref. RN 1720

Descrição

descripción / description

Batente Portão simples
Tope puerta simples
Gate stop simple





Ref. RN 650



Descrição

descripción / description

Puxador

Manilla espejo en cumbre
Handle with vertical base

Ref. RN 650 A



Descrição

descripción / description

Puxador

Manilla espejo en cumbre
Handle with vertical base

Ref. RN 660

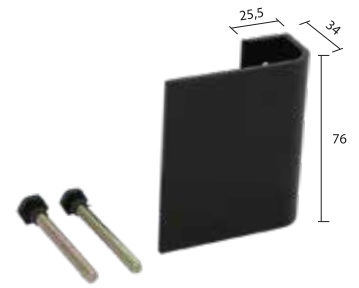

Descrição

descripción / description

Puxador

Manilla ??????????
Handle ??????????????

Ref. D.P.S.

Descrição

descripción / description

Dobradiça portão para soldar Alumínio

Bisagra puerta para soldar
Aluminio
Gate hinge to weld Aluminum

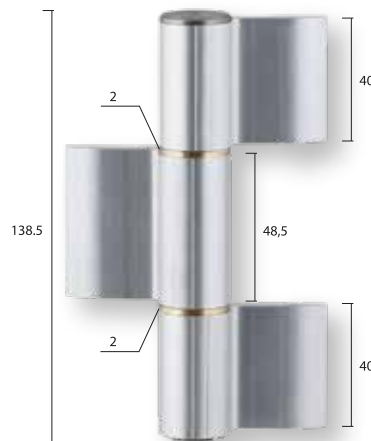

Ref. D.P.S. A

Descrição

descripción / description

Dobradiça portão simples para soldar Alumínio

Bisagra puerta simples para
soldar Aluminio
Simple gate hinge to weld
Aluminum



Ref. 2100

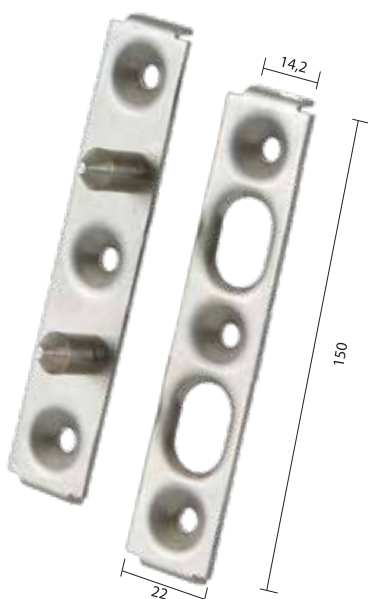

Descrição

Reforço de dobradiça em inox

Refuerzo de Bisagra acero
inoxidable
Hingereinforcement
stainless steel

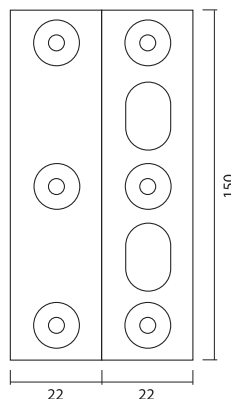

Descrição

Reforço de dobradiça em inox para canal 16 ou PVC

Refuerzo de Bisagra acero
inoxidable para canal 16 o PVC
/Hinge reinforcement
stainless steel for channel 16
or PVC

Ref. 2110





Ref. 2110

Descrição

descripción / description

Jogos Nadir Nº 2
Juegos Nadir
Nadir kit

Alumínio ou lacado
Aluminio o lacado
Aluminum or laquered



Ref. 2120

Descrição

descripción / description

Compasso Basculante
RN:93
Brújula de inclinación
Tilting compass

Medidas: 18 e 22
medidas / measure



Ref. 2130

Descrição

descripción / description

Compasso Basculante
RN:94
Brújula de inclinación
Tilting compass

Medidas: 18 e 22
medidas / measure



Ref. 2140

até 10 mm



Descrição

descripción / description

Fixador de vidro
Fijador de vidrio
Glass holder



Ref. D. A6 T



Descrição

descripción / description

Dobradiça Tripla
A6/6000
Bisagra triple
Triple hinge

Ref. D. A6



Descrição

descripción / description

Dobradiça A6/6000
Bisagra / Hinge

Ref. D. 2/F



Descrição

descripción / description

Dobradiça 2/F C. E.
Bisagra / Hinge

Ref. D. 2/F T



Descrição

descripción / description

Dobradiça Tripla C. E.
2/F
Bisagra triple
Triple hinge



Dobradiças

Bisagras / Hinges

Ref. **D. 3/F**



Descrição

descripción / description

Dobradiça 3/F
Bisagra / Hinge

Ref. **D. 3/F T**



Descrição

descripción / description

Dobradiça Tripla
3/F T
Bisagra triple
Triple hinge

Ref. **D. A7 c/AV**



Descrição

descripción / description

Dobradiça A7 c/AV
Bisagra / Hinge

Ref. **D. A7 c/AV T**



Descrição

descripción / description

Dobradiça Tripla
A7 c/AV
Bisagra triple
Triple hinge



Ref. D. HP



Descrição

descripción / description

Dobradiça HP
Bisagra / Hinge

Descrição

descripción / description

Dobradiça A7
Bisagra / Hinge

Ref. D. A7



Ref. D. C.E.



Descrição

descripción / description

Dobradiça C.E.
2F e 3F
Bisagra / Hinge

Descrição

descripción / description

Dobradiça Canal 16
Bisagra canal 16
Hinge channel 16

Ref. D.C.16



Ref. D.R.N.



Descrição

descripción / description

Dobradiça C.E. 3520 Forte
Bisagra / Hinge



Respiros

Rejilla de ventilación / Ventilation grill

Ref. **RN 1800**

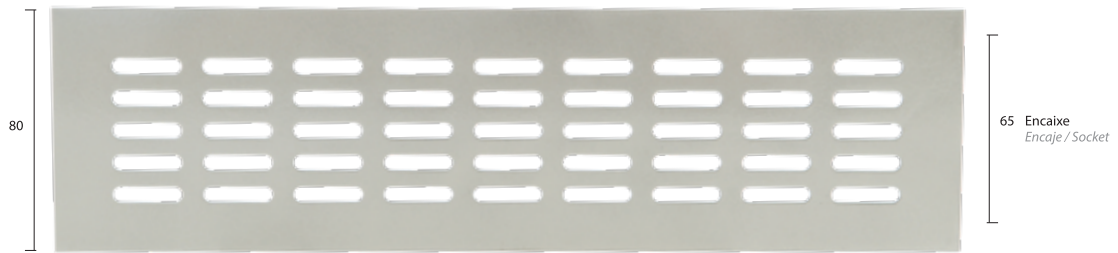

Descrição

descripción / description

Respiros Ventilação Exterior

Rejilla de ventilación exterior
Outdoor ventilation grill

Lacado

Lacado / Laquered

Ref. **RN 1800 A**



Descrição

descripción / description

Respiros Ventilação Interior

Rejilla de ventilación interior
Indoor ventilation grill

Lacado

Lacado / Laquered



Descrição

descripción / description

Veda Portas Colar
Pelucia 25
Sells puertas colar
Felpa
Door seals glue
Plush
80; 90; 100; 110; 120
Lacado
Lacado / Laquered



Ref. RN 2000 A



Descrição

descripción / description

Veda Portas
Vassoura 15
Sells puertas
Escoba
Door seals
Broom
80, 90, 100, 110, 120
Lacado
Lacado / Laquered

Descrição

descripción / description

Veda Portas
Borracha
Sells puertas
Goma
Door seals
Rubber
80, 90, 100, 110, 120
Lacado
Lacado / Laquered



Ref. RN 2000 B

Ref. RN 2000 C



Descrição

descripción / description

Veda Portas
Pelucia 12
Sells puertas
Felpa 12
Door seals
Plush 12
80, 90, 100, 110, 120
Lacado
Lacado / Laquered



RONIS
INDÚSTRIAS METALÚRGICAS, LDA.

SEDE:

RUA DO OUTEIRO - PAUS
3850-368 ALQUERUBIM
RONIS.LDA@HOTMAIL.COM

ACESSÓRIOS EM ALUMÍNIO:

RUA DO PORTINHO
ALAGOA
3750-320 ÁGUEDA
TEL./FAX: 234 646 859

LACAGEM:

CASAINHO DE BAIXO - ORONHE
3750 ÁGUEDA
TEL.: 234 624 436
FAX: 234 646 859